



THE POWER ENGINEERING COMPANY

The Innovation Week on R.E.S.
July 1 - 12, 2012, Patras, Greece
Session III : Solar Technologies in the Domestic sector

Smart Grids and Virtual Power Plants

Tuesday 3 July, 2012, Patras

Author:
Dr. eng. Mihai SĂNDULEAC
ECRO SRL, Bucharest, Romania



THE POWER ENGINEERING COMPANY

1.

What is Smart Grid?

Smart Grid: Power Systems V3.0

V 1.0

- Small independent power networks
- Various electrical standards (U, f, etc.)
- End of 19th century, first half of 20th century.

V 2.0

- Interconnected systems (national, transnational)
- Same electrical standards,
- “Smart” behavior only in transmission and big generators
- Second half of 20th century.

V 3.0 (Smart Grid)

- Synergetic functionality between power networks and IT systems
- Improved interconnectivity (combined AC and DC combine, intercontinental power networks)
- Intelligent behavior at all levels
- Energy ancillary services markets, evolving towards real-time
- First half of 21st century.

Observation: There are essential stages of 50 years in power systems development

So what is Smart Grid?

Some definitions:

- **SmartGrids (EU):** an electricity network that can intelligently integrate the actions of all users connected to it - generators, consumers and those that do both - in order to efficiently deliver sustainable, economic and secure electricity supplies. (<http://www.smartgrids.eu>)
- **Smart Grid Strategic Group (IEC):** a concept for modernizing the electricity networks which integrates electrical and information technologies in any point of the network, from generation to consumption.

Other possible definition:

- Synergic symbiosis of power and IT systems.



Smart Grid is an **Cyber-Energy System.**

Why Smart Grid?

Why now ?

General reasons for introducing Smart Grid:

- Renewables (PV, wind) need to be accommodated in the network;
- Need for more efficiency on the whole energy chain, with smaller prices for the final user (the only real payer !)
- It is needed a sustainable energy approach

Reasons which differ from country to country:

- Some countries have problems with integration of *high renewable energy level*;
- Some countries have mainly problems with *network congestion*;
- Some countries need new and flexible mechanisms for their advanced and still evolving energy and ancillary systems markets.



THE POWER ENGINEERING COMPANY

2.

Some specific technologies for implementing the Smart Grid

Smart Grid specific technologies

1. Energy Web – an information web for supporting Smart Grid decisions

It is a logical *Information web* - dedicated to power systems functionality, which is usually superposed / using the classic Internet, acting like a VPN or cloud.

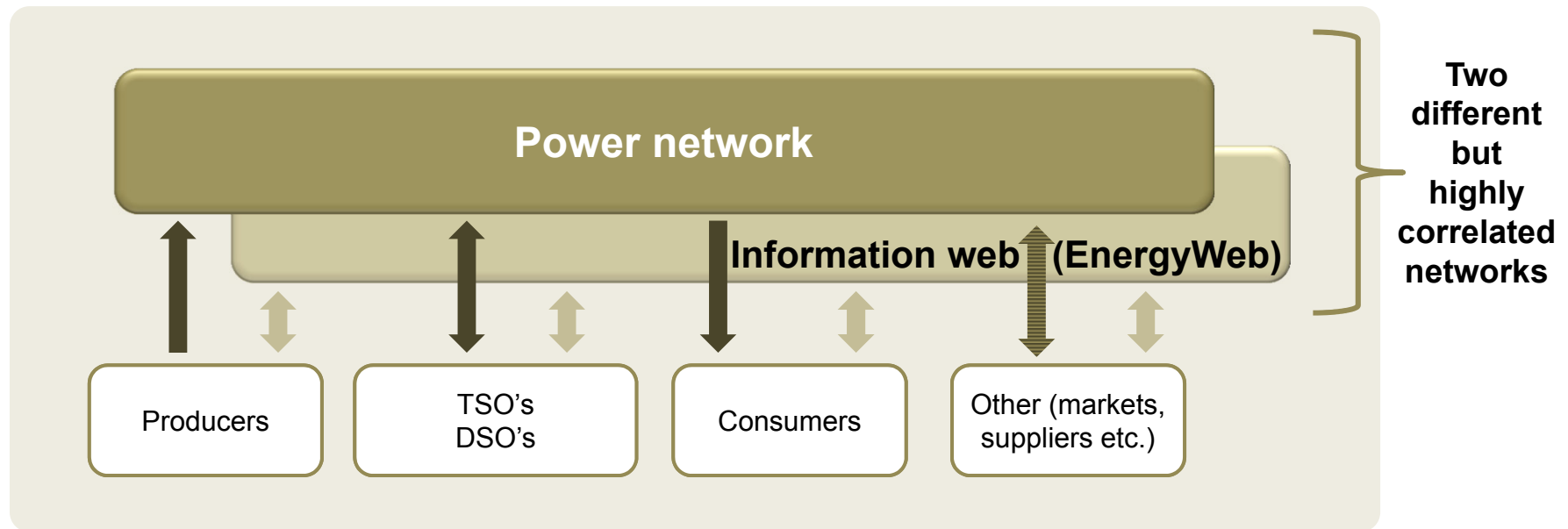

Smart Grid specific technologies

2.

Virtual Power Plant (VPP)

Virtual Power Plant allows coupling of **Distributed Energy Resources (DER)** at the existing commercial and technical platforms by using *intelligent aggregation*.

Observation: **PV production**, especially in Domestic sector, is suitable to be integrated in VPPs

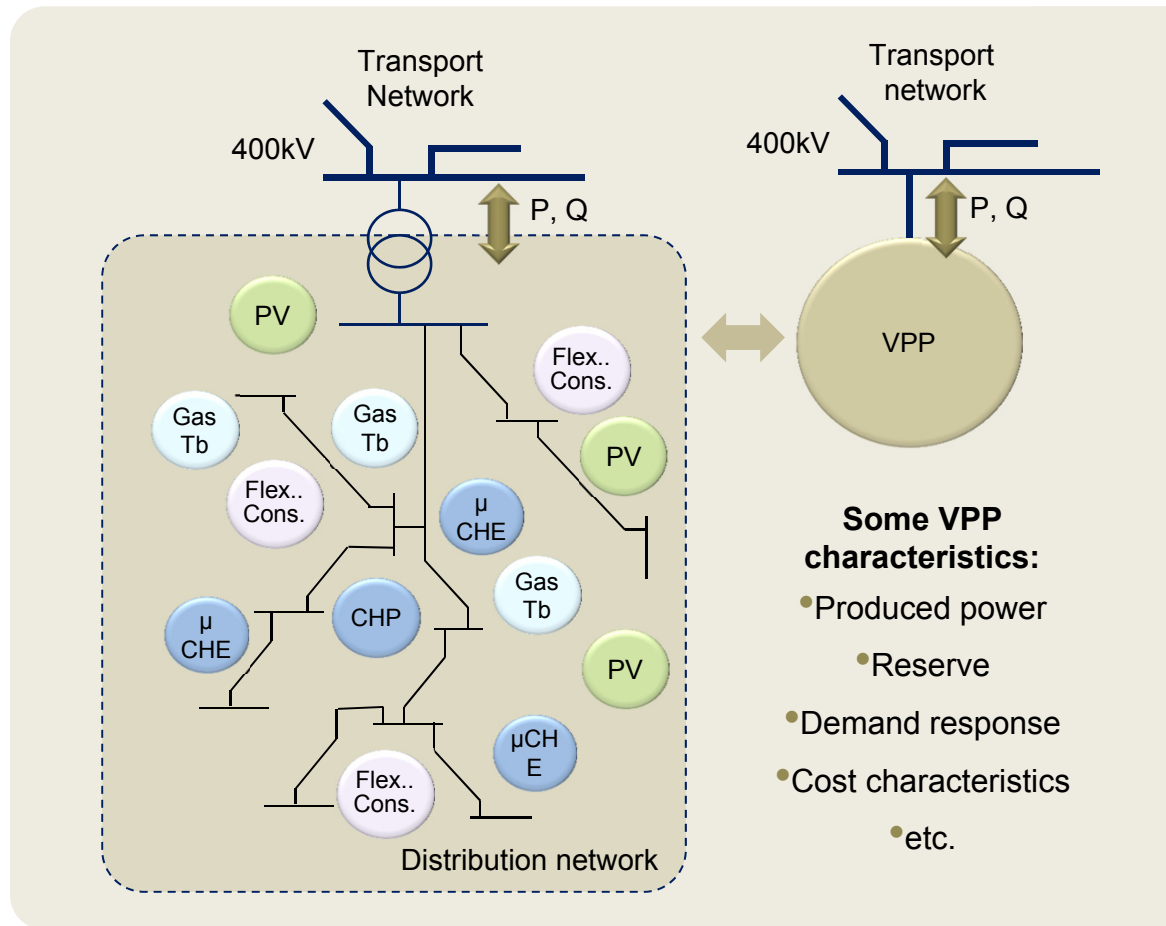

Smart Grid specific technologies

3.

Smart Meters (SM)

In many country politics, Smart Meters are at the basis of the Smart Grid roadmap.

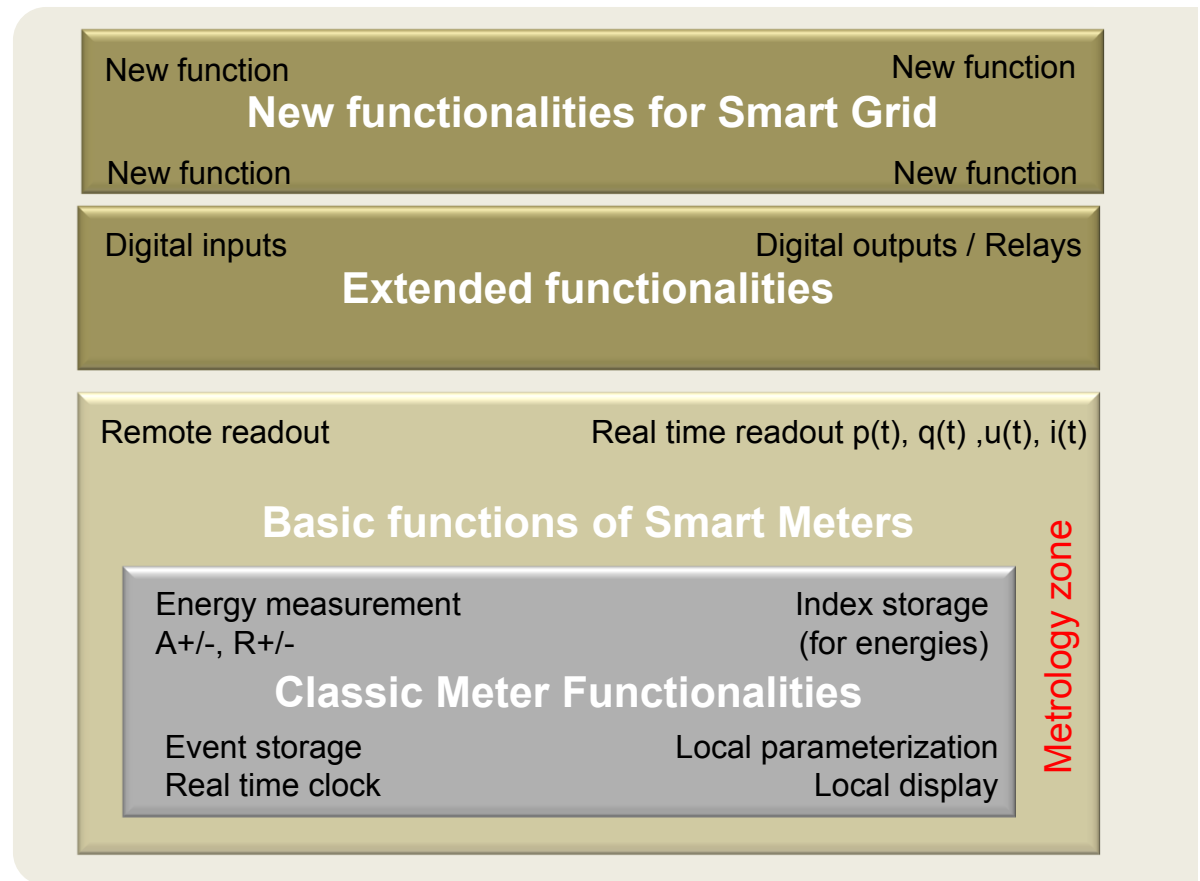

Stacked functionalities in the Smart Meter

Smart Grid specific technologies

4.

Intelligent Energy Portals (IEP)

It is an intelligent B2B interface between DER and other Smart Grid participants

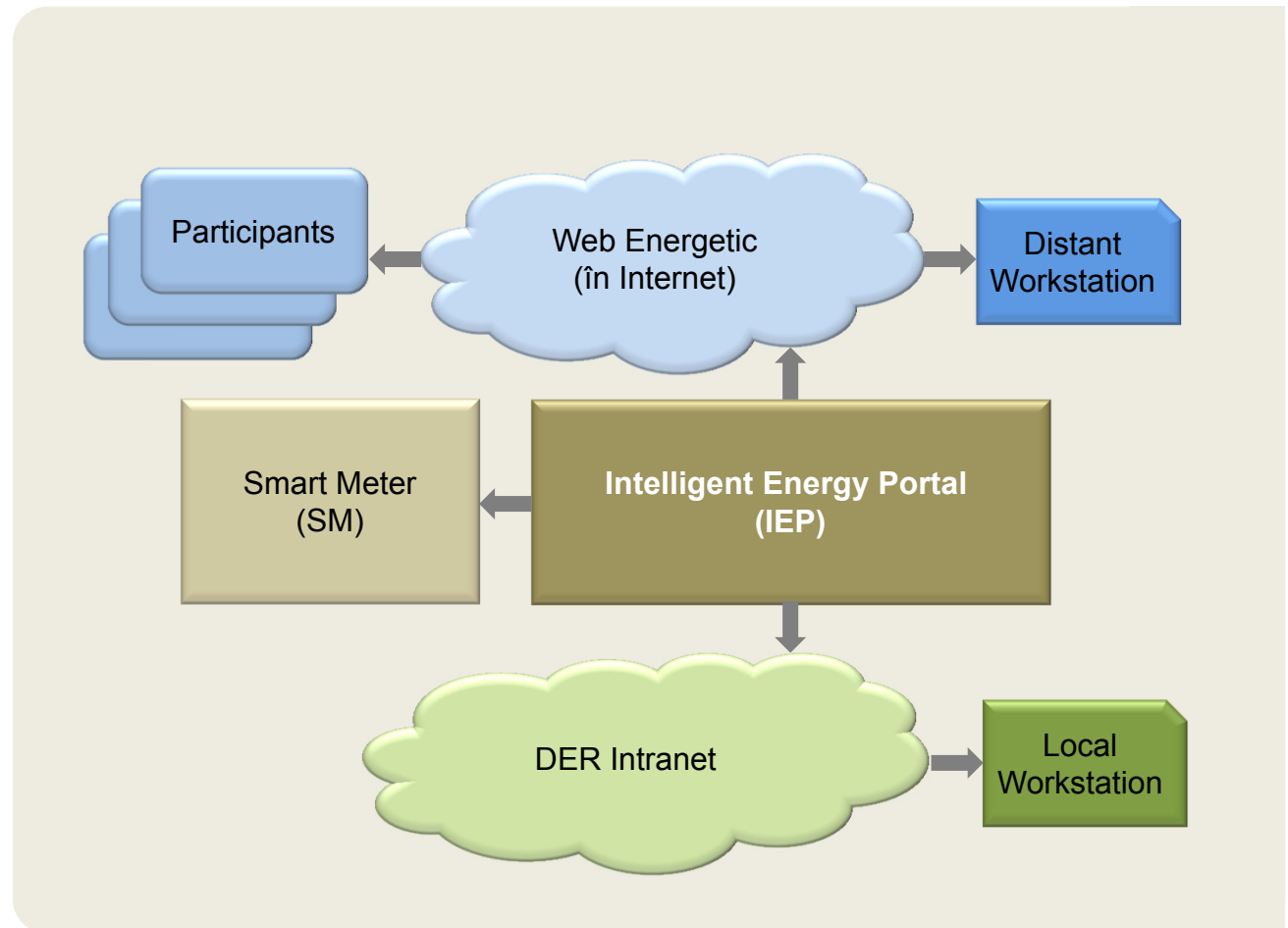

Smart Grid specific technologies

5. ...

SIPS - System Integrity Protection Schemes

PMU - Power Measurement Units

HVDC - High Voltage Direct Current

FACTS - Flexible Alternating Current
Transmission System

.....



THE POWER ENGINEERING COMPANY

3.

Smart Meter

Basic start-up element in many Smart Grid architectures

Existing Smart Meter: diversity, non-standardization

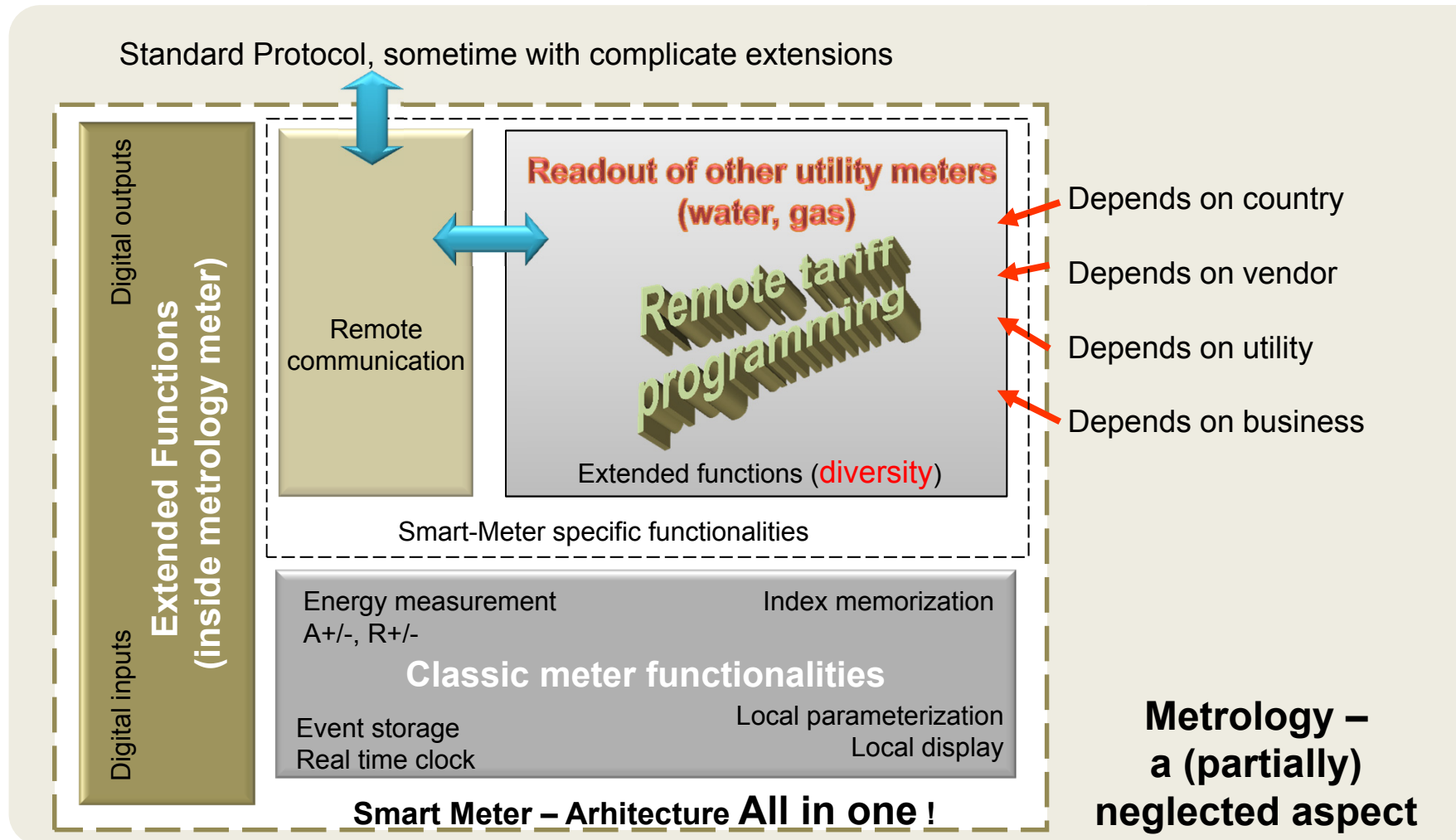

Smart Meter – a basis for the Smart Grid

Definition of its basic functions

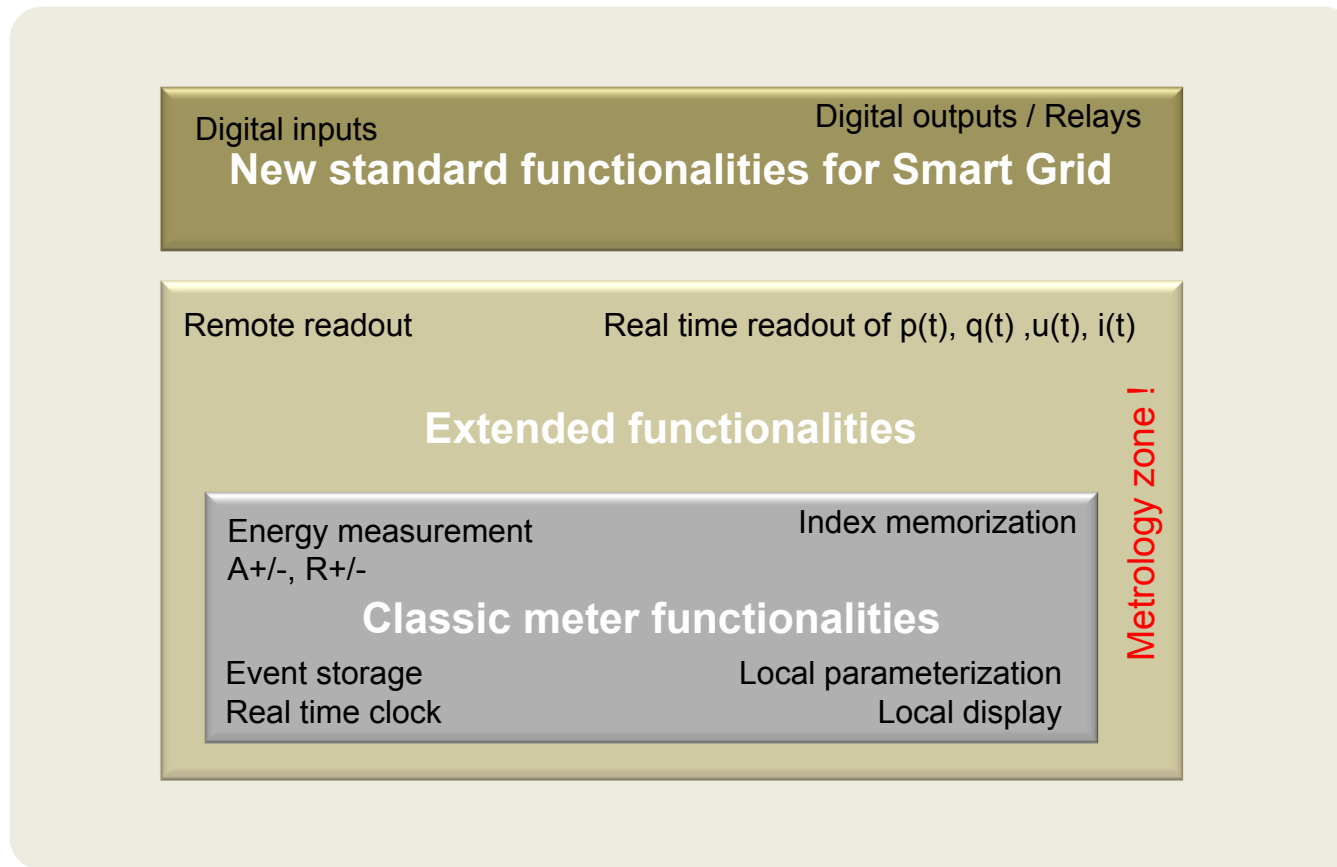

In top of these functions of the **Smart Meter** can be built the entire **Smart Grid** functionality and (any) associated business model

Un-bundled Smart Meter – at the basis of the Smart Grid functionality

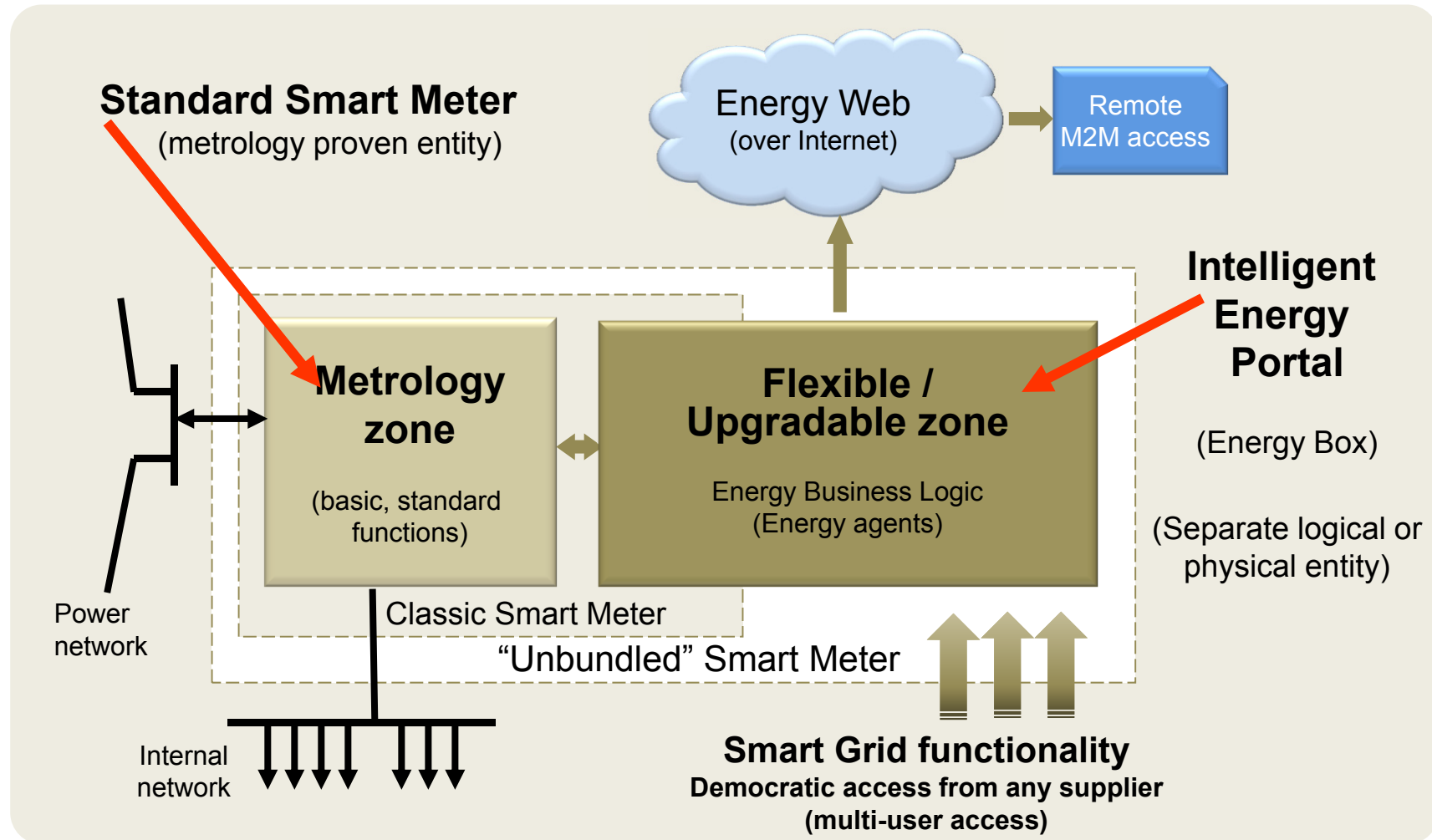

Place of Smart Meter and of IEP in Smart Grid architecture

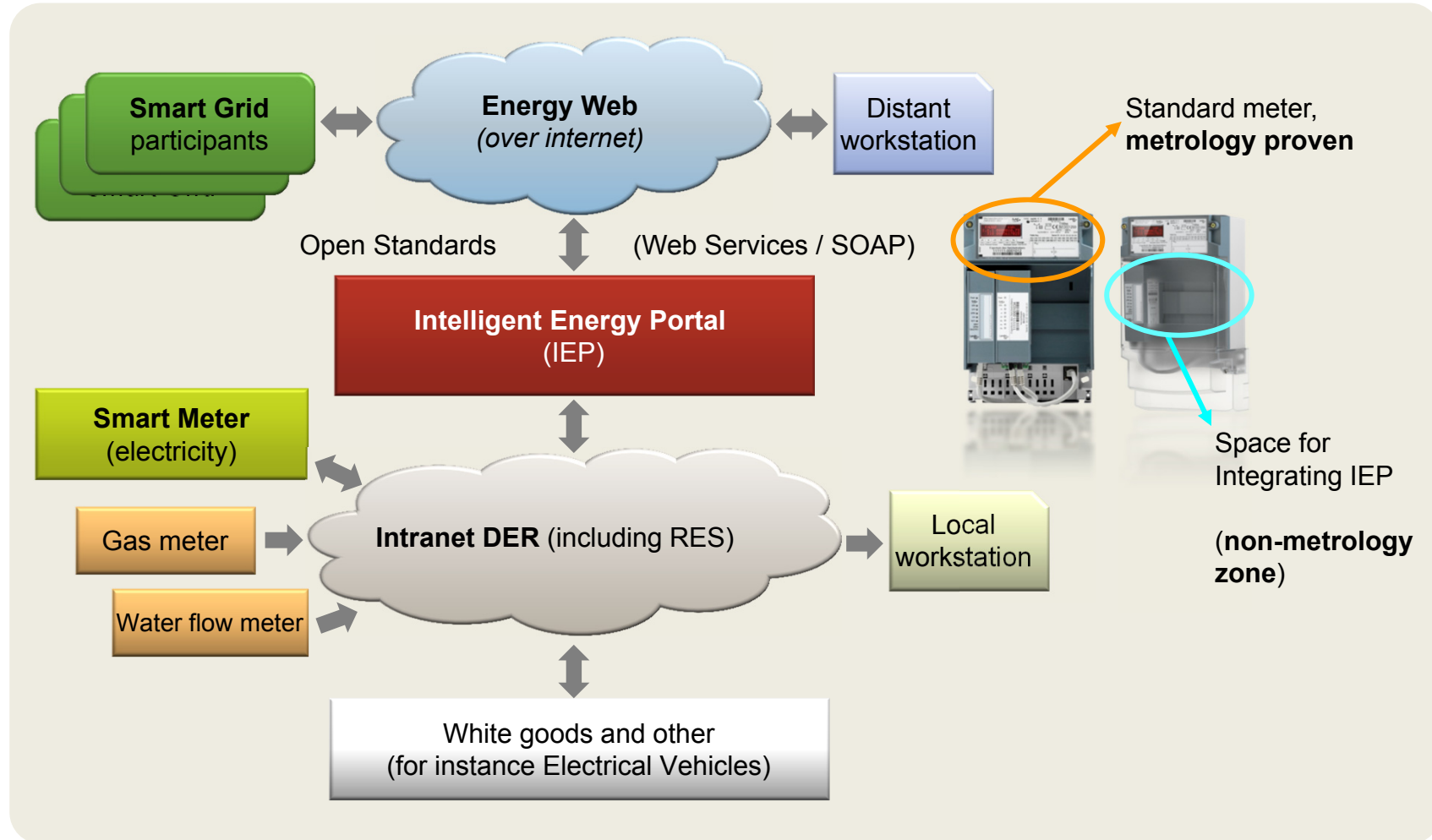



THE POWER ENGINEERING COMPANY

4.

Virtual Power Plants

Applications

1. VPP used for selling aggregated energy

Small renewables aggregated in bigger VPPs ($P > 10$ MW)

Energy markets request bigger quantities compared with RES production

Domestic PV have even smaller unitary production outputs

Production control is easier to achieve with combined resources (e.g. RES + controllable gas generators)

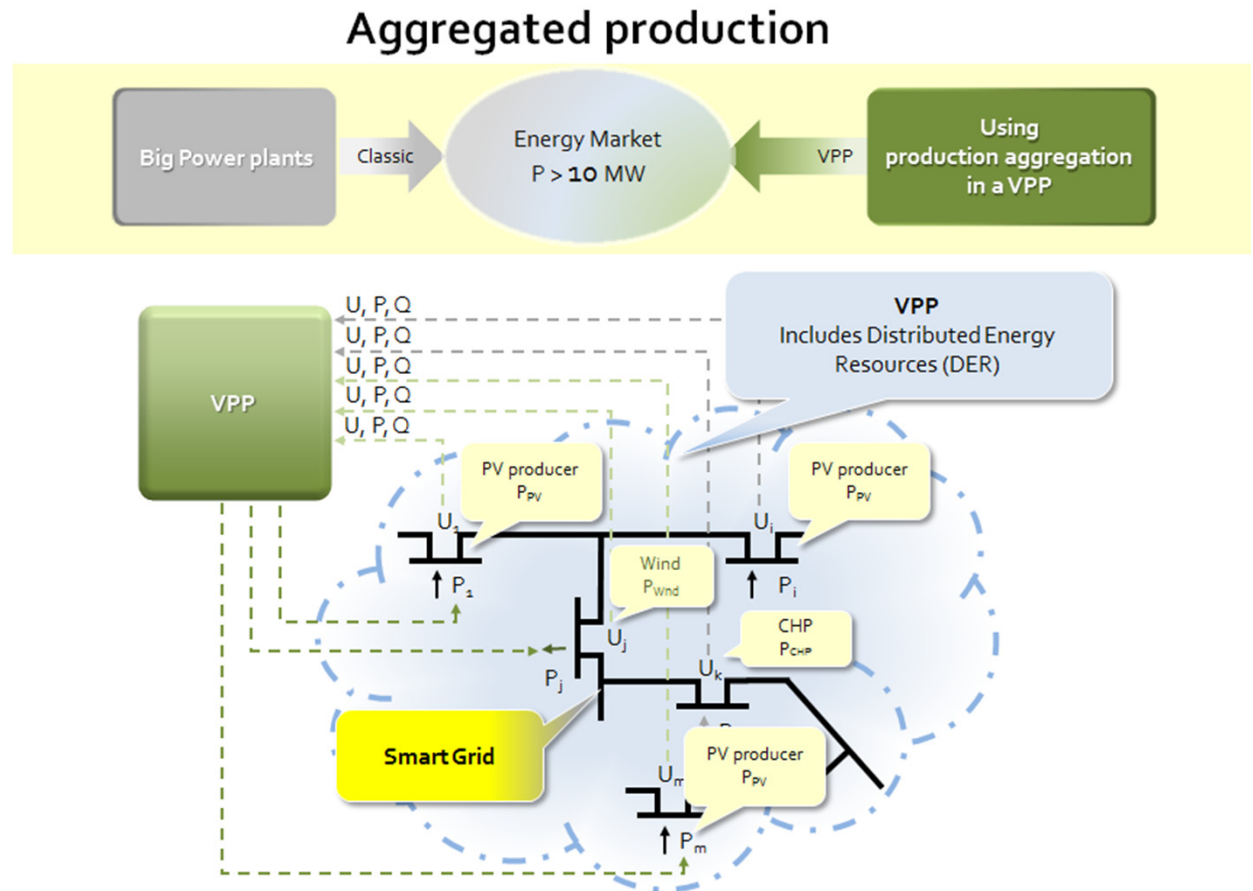

2. VPP used for ancillary services

Fast tertiary reserve with VPPs

Flexible generation need to offer band exceeding a threshold value (e.g. $P_{BAND} > 10 \text{ MW}$).

RES can occasionally reduce power in special network cases, but small generation need to be aggregated

VPP is one solution for tertiary reserve, especially for decreasing power.

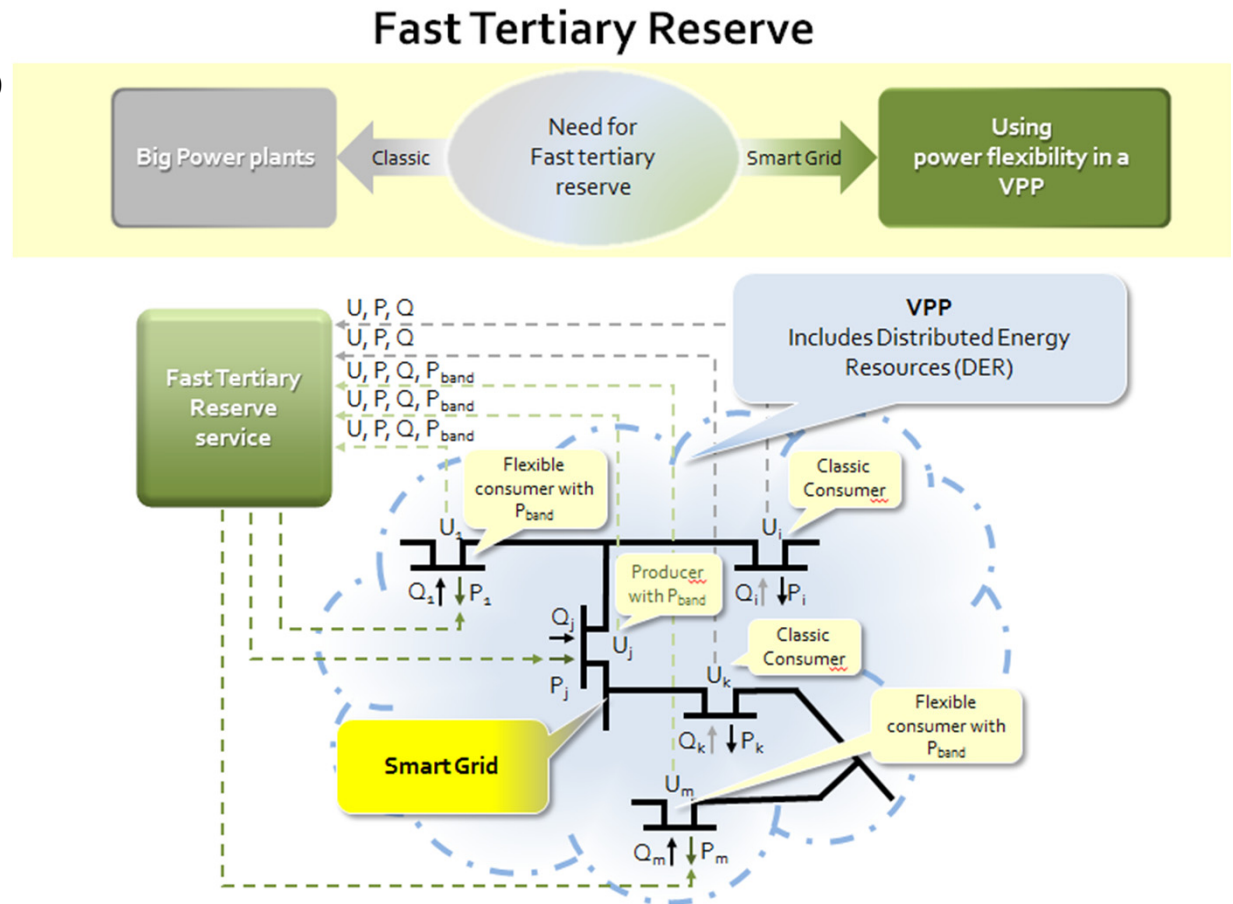

2. VPP used for quality of energy supply

Voltage secondary control with VPPs

Flexibility in Q control (reactive power) is not usually used with RES.

RES can modulate Q through their inverter, but small Q generation need also to be aggregated

VPP is one solution for voltage secondary reserve.

RES with inverter (such as PV) can profit with VPP.

Voltage secondary control

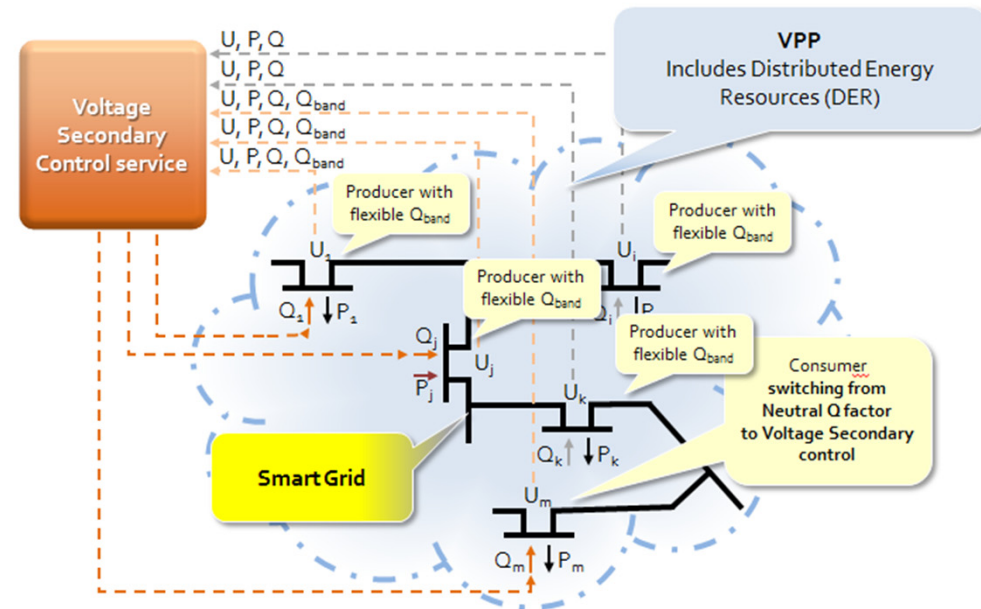

2. VPP used for providing services to a Balancing Responsible Entity (BRE)

A Balancing Responsible Entity (BRE) need to reduce imbalance each commercial interval (usually each 1 hour)

RES with other generators and storage devices can be orchestrated to reduce imbalance

VPP is one solution for balancing in BRE.

Active balancing in a BRE

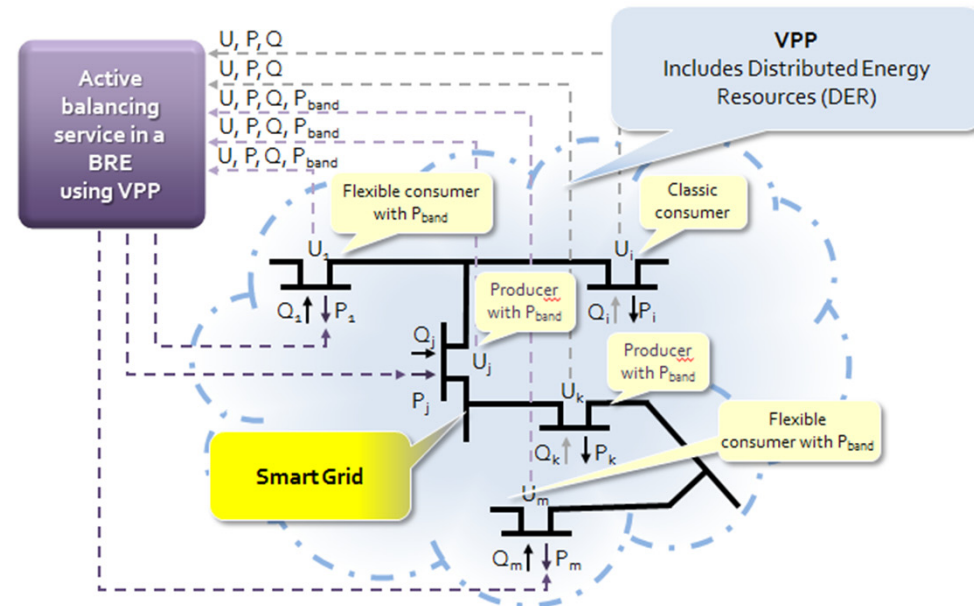
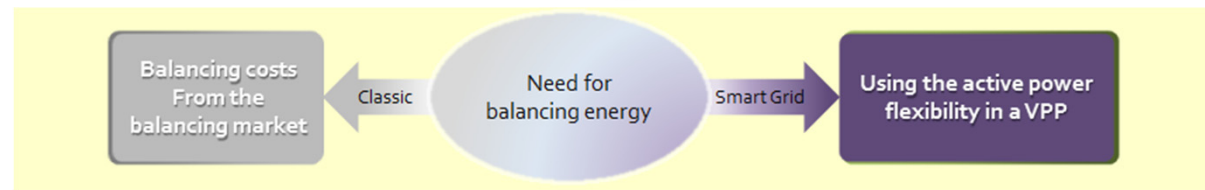



THE POWER ENGINEERING COMPANY

5.

Smart Grid – future developments

Smart Grid – Projection to the future

Let's look at the Smart Grid in the future:

- Order of magnitude: 1+ billion prosumer entities (one for each house and commercial entity)
- Each entity has one or many energy sources (PV, wind, fuel cells etc.) and a flexible consumption
- Storage will be both centralized and distributed
- The whole system should work without major problems 24/24 and 365/365, on long term (for instance 5-10 years, till a new technology generation is available).

Difficult requirements. Can they be achieved?

Smart Grid – simplified road-map

DOE from USA estimates that there are at least 2 stages to be **followed**:

- In a first stage, it will be implemented a “smarter network” – probably in the next 10 years;
- In a second stage Smart Grid will produce that kind of structural change in our way of how we live, work and learn, which is comparable only with the one brought by the **Internet** [DOE 2008].

Smart Grid is the „*Holly Grail*” of energy and IT sector

Smart Grid ... a solution through democracy

This is why it is needed a flexible and “democratic” approach in key zones such as:

- At meter level (Un-bundled Smart Meter);
- At Energy-Web level: web open standards

These are necessary prerequisites to ensure a large accessibility, to boost the technological imagination and to evolve as quick as possible towards a

Cyber-Energy System.

Thank you for your attention!

Adresa: Str. Precupeții Vechi nr.6, sector 2, 0206845, București, România
Tel.: +40 21-210.88.88, Fax: +40 21-211.49.94
Mail: office(la)ecro.ro

www.ecro.ro



THE POWER ENGINEERING COMPANY